

A5 package: 750V 550A IGBT module

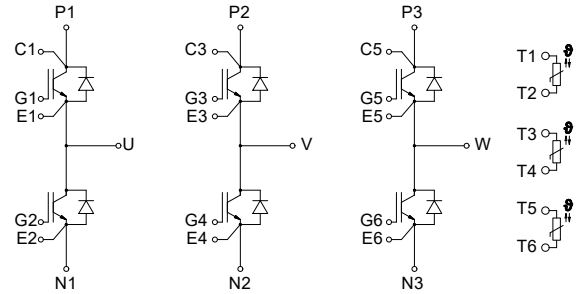
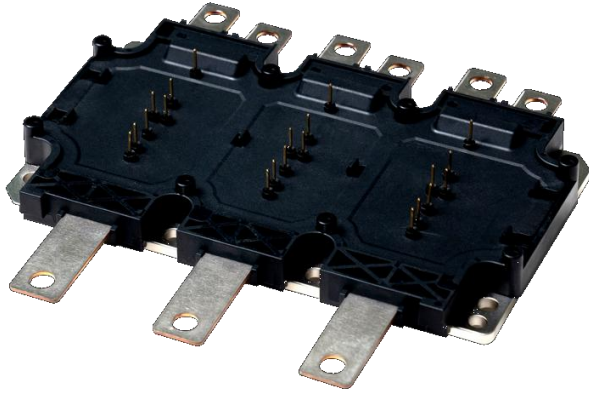

等效电路图
Equivalent Circuit Schematic

Features:

- 750V 550A, $V_{CE(sat)} = 1.35V@25^{\circ}C$
- High RBSOA capability
- Micro pattern trench/FS technology
- Low switching losses
- High SC capability
- Direct Cooled Base Plate with PinFin

产品特性:

- 750V 550A, $V_{CE(sat)} = 1.35V@25^{\circ}C$
- 高 RBSOA 能力
- 微沟槽/场终止技术
- 低开关损耗
- 高短路能力
- 直接冷却 PinFin 基板

Typical Applications:

- Automotive Applications
- Motor Drives
- Inverters

典型应用:

- 汽车应用
- 电机驱动
- 逆变器

IGBT, Inverter / IGBT, 逆变部分
Maximum Rated Values / 最大标称参数

Collector-emitter voltage 集电极-发射极电压	$T_{vj}=25^{\circ}\text{C}$	V_{CES}	750	V
Continuous DC collector current 集电极连续直流电流		$I_{C\text{ nom}}$	550	A
	$T_C=65^{\circ}\text{C}, T_{vj\text{ max}}=175^{\circ}\text{C}$	I_C	539 ¹⁾	A
Repetitive peak collector current 集电极可重复峰值电流	$t_p=1\text{ms}$	I_{CRM}	1100	A
Total power dissipation 功率损耗	$T_C=75^{\circ}\text{C}, T_{vj\text{ max}}=175^{\circ}\text{C}$	P_{tot}	685 ¹⁾	W
Gate-emitter peak voltage 门极-发射极峰值电压		V_{GES}	± 20	V

Characteristic Values / 性能参数

				min.	typ.	max.	
Collector-emitter saturation voltage 集电极-发射极饱和压降	$I_C=600\text{A}, V_{GE}=15\text{V}$	$T_{vj}=25^{\circ}\text{C}$ $T_{vj}=150^{\circ}\text{C}$ $T_{vj}=175^{\circ}\text{C}$	V_{CESat}		1.35 1.50 1.54		V
Gate threshold voltage 门极阈值电压	$V_{CE}=V_{GE}, I_C=8\text{mA}$	$T_{vj}=25^{\circ}\text{C}$	V_{GEth}	5.00	6.00	7.00	V
Internal gate resistor 内置门极电阻		$T_{vj}=25^{\circ}\text{C}$	R_{Gint}		0.65		Ω
Input capacitance 输入电容	$V_{CE}=25\text{V}, V_{GE}=0\text{V}, f=100\text{kHz}$	$T_{vj}=25^{\circ}\text{C}$	C_{ies}		70.6		nF
Reverse transfer capacitance 反向传输电容	$V_{CE}=25\text{V}, V_{GE}=0\text{V}, f=100\text{kHz}$	$T_{vj}=25^{\circ}\text{C}$	C_{res}		0.26		nF
Gate charge 门极电荷	$V_{GE}=-8\text{V}\sim+15\text{V}, V_{CE}=400\text{V}$		Q_G		2.92		μC
Collector-emitter cut-off current 集电极-发射极关断漏电流	$V_{CE}=750\text{V}, V_{GE}=0\text{V}$	$T_{vj}=25^{\circ}\text{C}$	I_{CES}			1.0	mA
Gate-emitter leakage current 门极-发射极漏电流	$V_{CE}=0\text{V}, V_{GE}=20\text{V}$	$T_{vj}=25^{\circ}\text{C}$	I_{GES}			500	nA
Turn-on delay time, inductive load 开通延迟时间, 感性负载	$I_C=450\text{A}, V_{CE}=400\text{V}$ $V_{GE}=-8\text{V}/15\text{V}, R_{Gon}=1.0\Omega$	$T_{vj}=25^{\circ}\text{C}$ $T_{vj}=150^{\circ}\text{C}$ $T_{vj}=175^{\circ}\text{C}$	t_{don}		99 119 124		ns
Rise time, inductive load 上升时间, 感性负载	$I_C=450\text{A}, V_{CE}=400\text{V}$ $V_{GE}=-8\text{V}/15\text{V}, R_{Gon}=1.0\Omega$	$T_{vj}=25^{\circ}\text{C}$ $T_{vj}=150^{\circ}\text{C}$ $T_{vj}=175^{\circ}\text{C}$	t_r		53 62 64		ns
Turn-off delay time, inductive load 关断延迟时间, 感性负载	$I_C=450\text{A}, V_{CE}=400\text{V}$ $V_{GE}=-8\text{V}/15\text{V}, R_{Goff}=8\Omega$	$T_{vj}=25^{\circ}\text{C}$ $T_{vj}=150^{\circ}\text{C}$ $T_{vj}=175^{\circ}\text{C}$	t_{doff}		729 810 822		ns
Fall time, inductive load 下降时间, 感性负载	$I_C=450\text{A}, V_{CE}=400\text{V}$ $V_{GE}=-8\text{V}/15\text{V}, R_{Goff}=8\Omega$	$T_{vj}=25^{\circ}\text{C}$ $T_{vj}=150^{\circ}\text{C}$ $T_{vj}=175^{\circ}\text{C}$	t_f		76 130 142		ns
Turn-on energy loss per pulse 开通损耗	$I_C=450\text{A}, V_{CE}=400\text{V}$ $V_{GE}=-8\text{V}/15\text{V}, R_{Gon}=1.0\Omega,$ $di/dt(T_{vj}=25^{\circ}\text{C})=6818\text{A/us}$ $di/dt(T_{vj}=175^{\circ}\text{C})=5648\text{A/us}$	$T_{vj}=25^{\circ}\text{C}$ $T_{vj}=150^{\circ}\text{C}$ $T_{vj}=175^{\circ}\text{C}$	E_{on}		9.6 14.5 15.8		mJ
Turn-off energy loss per pulse 关断损耗	$I_C=450\text{A}, V_{CE}=400\text{V}$ $V_{GE}=-8\text{V}/15\text{V}, R_{Goff}=8\Omega$ $dv/dt(T_{vj}=25^{\circ}\text{C})=7143\text{A/us}$ $dv/dt(T_{vj}=175^{\circ}\text{C})=4365\text{A/us}$	$T_{vj}=25^{\circ}\text{C}$ $T_{vj}=150^{\circ}\text{C}$ $T_{vj}=175^{\circ}\text{C}$	E_{off}		24.5 31.2 32.3		mJ

SC data 短路耐量	$V_{CC}=400V$, $V_{GE}=-8V/15V$ $t_p \leq 6\mu s$ $T_{vj}=25^\circ C$ $V_{CEmax}=V_{CES}-L_{sCE} \cdot di/dt$ $t_p \leq 3\mu s$ $T_{vj}=175^\circ C$	I_{sc}		2940 2380		A
Thermal resistance, junction to cooling fluid 结-冷却液热阻	Per IGBT/单个 IGBT Cooling fluid = 50%water/50% ethylene glycol; $\Delta V/\Delta T=10.0dm^3/min$ $T_F=65^\circ C$	R_{thJF}		0.146		K/W
Temperature under switching conditions 工作温度	t_{op} continuous for 10s within a period of 30s, occurrence maximum 3000 times over lifetime	$T_{vj op}$	-40 150		150 175	$^\circ C$

Diode, Inverter / 二极管, 逆变部分

Maximum Rated Values / 最大标称参数

Repetitive peak reverse voltage 可重复反向峰值电压	$T_{vj}=25^\circ C$	V_{RRM}	750	V
Continuous DC forward current 可连续正向直流电流		I_{Fnom}	550	A
Repetitive peak forward current 可重复正向峰值电流	$I_{FRM}=2 \times I_F$	I_{FRM}	1100 ¹⁾	A

Characteristic Values / 性能参数

		min. typ. max.			
Forward voltage ¹⁾ 正向通态压降	$I_F=600A$, $V_{GE}=0V$	$T_{vj}=25^\circ C$ $T_{vj}=150^\circ C$ $T_{vj}=175^\circ C$	V_F	1.45 1.40 1.35	V
Reverse recovery time 反向恢复时间	$I_F=450A$, $V_R=400V$ $di_F/dt=4761A/us(T_{vj}=150^\circ C)V_{GE}=-8V$	$T_{vj}=25^\circ C$ $T_{vj}=150^\circ C$ $T_{vj}=175^\circ C$	t_{rr}	114 217 240	ns
Peak reverse recovery current 反向恢复峰值电流	$I_F=450A$, $V_R=400V$ $di_F/dt=4761A/us(T_{vj}=150^\circ C)V_{GE}=-8V$	$T_{vj}=25^\circ C$ $T_{vj}=150^\circ C$ $T_{vj}=175^\circ C$	I_{RM}	286 354 366	A
Recovery charge 反向恢复电荷	$I_F=450A$, $V_R=400V$ $di_F/dt=4761A/us(T_{vj}=150^\circ C)V_{GE}=-8V$	$T_{vj}=25^\circ C$ $T_{vj}=150^\circ C$ $T_{vj}=175^\circ C$	Q_R	19.4 36.5 40.9	μC
Reverse recovery energy 反向恢复损耗	$I_F=450A$, $V_R=400V$ $di_F/dt=4761A/us(T_{vj}=150^\circ C)V_{GE}=-8V$	$T_{vj}=25^\circ C$ $T_{vj}=150^\circ C$ $T_{vj}=175^\circ C$	E_{rec}	5.3 10.4 12.0	mJ
Thermal resistance, junction to cooling fluid 结-冷却液热阻	Per FRD/单个 FRD Cooling fluid = 50%water/50% ethylene glycol; $\Delta V/\Delta T=10.0dm^3/min$ $T_F=65^\circ C$		R_{thJF}	0.214	K/W
Temperature under switching conditions 工作温度	t_{op} continuous for 10s within a period of 30s, occurrence maximum 3000 times over lifetime	$T_{vj op}$	-40 150	150 175	$^\circ C$

NTC-Thermistor/ NTC-热敏电阻
Characteristic Values / 性能参数

		min.	typ.	max.		
Rated resistance 标称电阻	$T_{NTC}=25^{\circ}C$	R_{25}	-	5	-	K Ω
Deviation of R100 R100 偏移值	$T_{NTC}=100^{\circ}C, R_{100}=493.3\Omega$	$\Delta R/R$	-5	-	5	%
Power dissipation 功率耗散	$T_{NTC}=25^{\circ}C$	P_{25}	-	-	20	mW
B-value B 值	$R_2=R_{25} \exp[B_{25/50}(1/T_2-1/(298.15K))]$	$B_{25/50}$	-	3375	-	K
	$R_2=R_{25} \exp[B_{25/80}(1/T_2-1/(298.15K))]$	$B_{25/80}$	-	3414	-	K
	$R_2=R_{25} \exp[B_{25/100}(1/T_2-1/(298.15K))]$	$B_{25/100}$	-	3436	-	K

Module / 模块

Isolation test voltage 绝缘测试电压	RMS, f=0Hz, t=1sec	V_{ISOL}	4.2		KV
Material of module baseplate 模块底板材料			Cu+Ni		
Internal isolation 内部绝缘			ZTA		
Creepage distance 爬电距离	Terminal to heatsink Terminal to terminal		9.0 9.0		mm
Clearance 电气间隙	Terminal to heatsink Terminal to terminal		4.5 4.5		mm
Comparative tracking index 相对漏电起痕指数		CTI	> 200		

		min.	typ.	max.		
Stray inductance module 模块杂散电感		L_{sCE}	-	13	-	nH
Module lead resistance, terminals- chip 模块引脚电阻, 端子-芯片	$T_C=25^{\circ}C, \text{ Per Switch}$	$R_{CC'+EE'}$	-	1.0	-	m Ω
Storage temperature 贮存温度		T_{stg}	-40	-	125	$^{\circ}C$
Mounting torque for module mounting 模块安装力矩	Screw M4 / M4 螺丝 Baseplate to heatsink Screw EJOT delta/自攻螺丝 PCB to frame	M	1.8 0.45	-	2.2 0.55	Nm
Terminal connection torque 功率端子连接力矩	Screw M6 / M6 螺丝	M	4.0	-	6.0	Nm
Weight 重量		G	-	600	-	g

- 1) Verified by characterization/design not by test.
非测试值, 设计计算所得。

Circuit Diagram / 曲线图

Output characteristic IGBT, Inverter (typical), Inclusive $R_{CC'+EE'}$

IGBT 输出特性, 逆变 (典型值), 包含 $R_{CC'+EE'}$
 $I_C=f(V_{CE}), V_{GE}=15V$

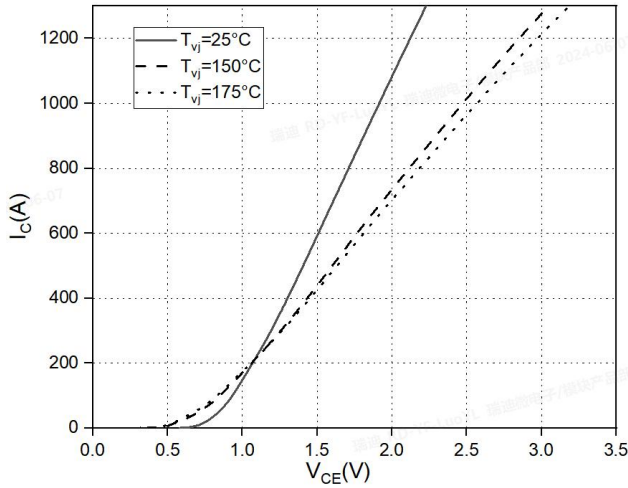

Output characteristic IGBT, Inverter (typical), Inclusive $R_{CC'+EE'}$

IGBT 输出特性, 逆变 ($T_j=150^\circ C$), 包含 $R_{CC'+EE'}$
 $I_C=f(V_{CE}), T_{vj}=175^\circ C$

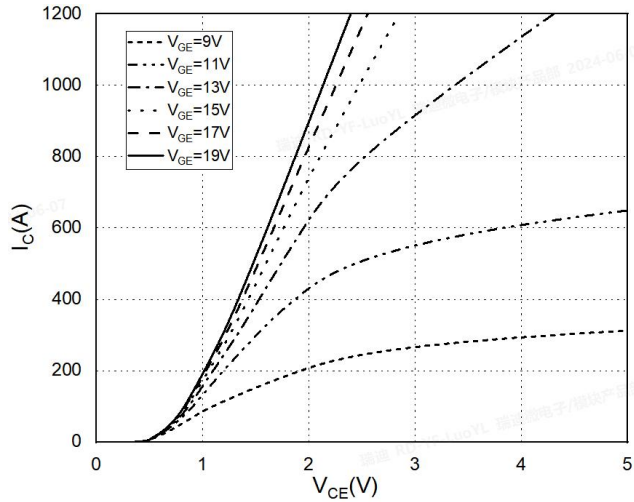

Transfer characteristic IGBT, Inverter (typical), Inclusive $R_{CC'+EE'}$

IGBT 传输特性, 逆变 (典型值), 包含 $R_{CC'+EE'}$
 $I_C=f(V_{GE}), V_{CE}=20V$

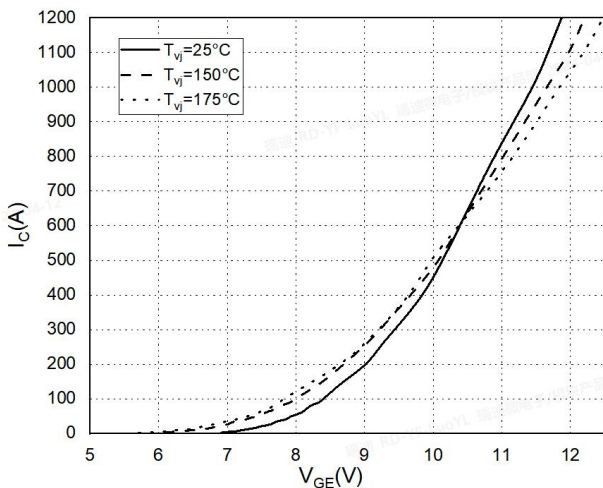

Switching losses IGBT, Inverter (typical), Inclusive $R_{CC'+EE'}$

IGBT 开关损耗, 逆变 (典型值), 包含 $R_{CC'+EE'}$
 $E=f(I_C), V_{GE}=+15V/-8V,$
 $R_{Gon}=1\Omega, R_{Goff}=8\Omega, V_{CE}=400V$

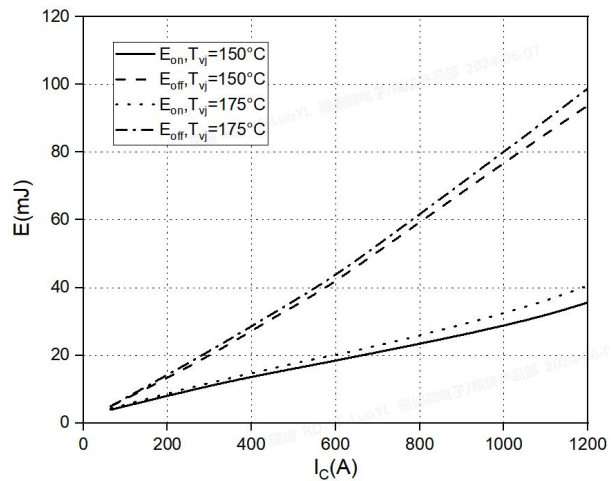

Switching losses IGBT, Inverter (typical), Inclusive R_{CC+EE}

IGBT 开关损耗, 逆变 (典型值), 包含 R_{CC+EE}
 $E_{on}=f(R_G), E_{off}=f(R_G)$
 $V_{GE}=+15V/-8V, I_C=450A, V_{CE}=400V$

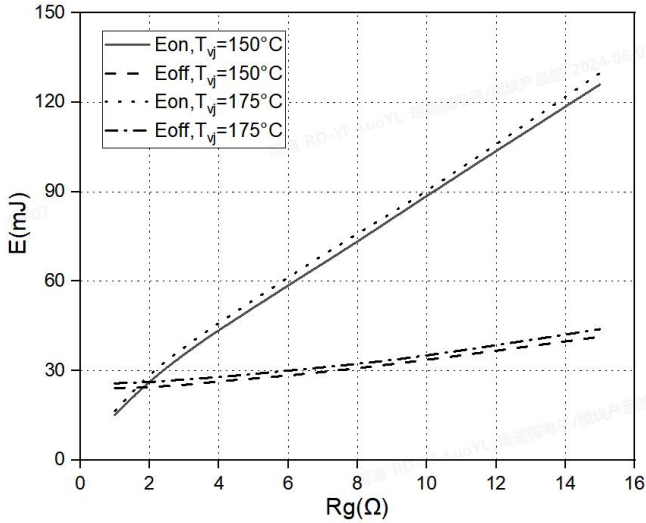

Transient thermal impedance IGBT, Inverter

IGBT 瞬态热阻, 逆变
 $Z_{thJC}=f(t)$
 Cooling fluid = 50% water/50% ethylene glycol;
 $\Delta V/\Delta T=10.0 dm^3/min; T_F=65^\circ C$

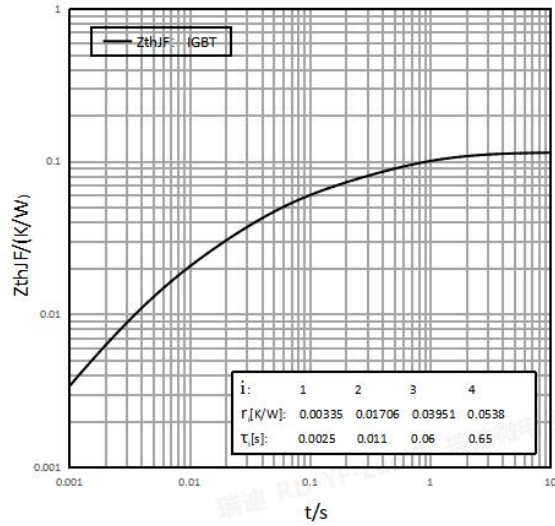

Reverse bias safe operating area IGBT, Inverter (RBSOA)

IGBT 反向安全工作区, 逆变 (RBSOA)
 $I_C=f(V_{CE}), V_{GE}=+15V/-8V, R_{Goff}=12\Omega, T_{vj}=175^\circ C$

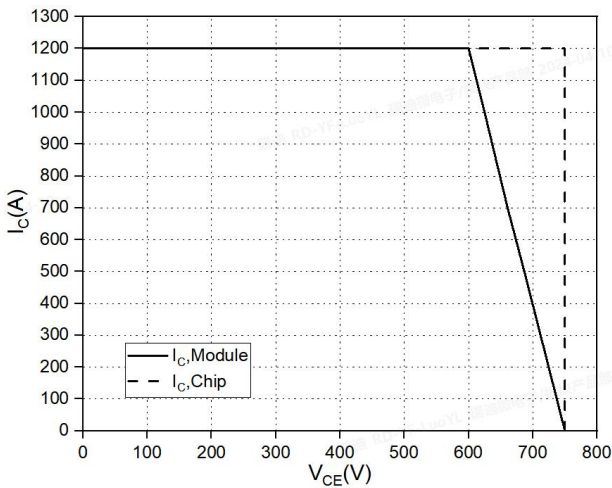

Forward characteristic FRD, Inverter (typical), Inclusive R_{CC+EE}

FRD 正向特性, 逆变 (典型值), 包含 R_{CC+EE}
 $I_F=f(V_F)$

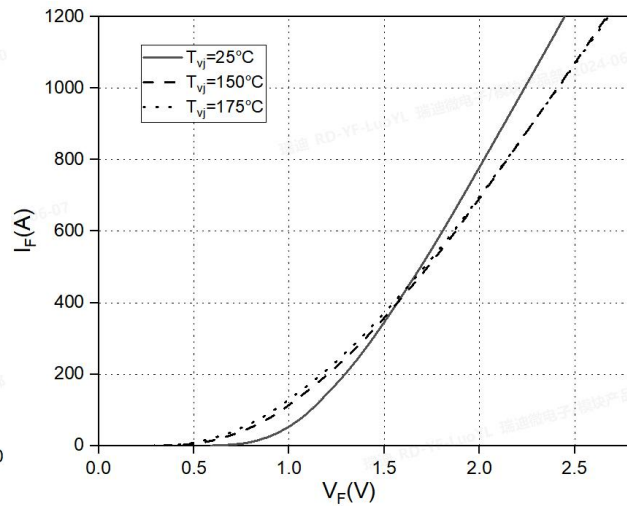

Switching losses FRD, Inverter (typical),

Inclusive $R_{CC}+EE'$

FRD 开关损耗, 逆变 (典型值), 包含 $R_{CC}+EE'$

$E_{rec}=f(I_F), R_{Gon}=1\Omega, V_{CE}=400V$

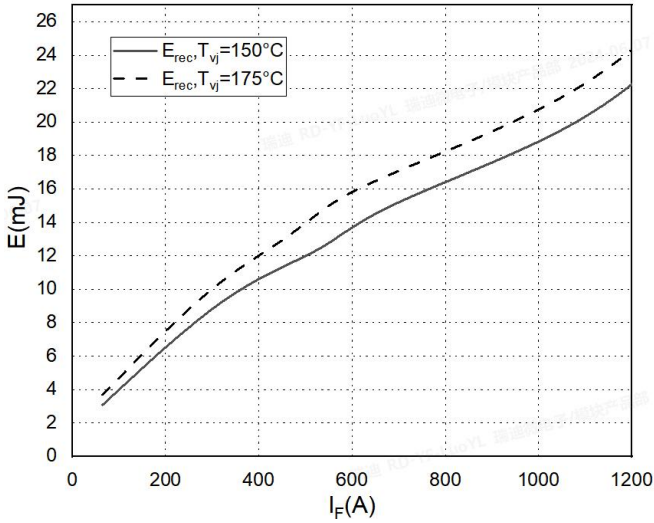

Switching losses FRD, Inverter (typical),

Inclusive $R_{CC}+EE'$

FRD 开关损耗, 逆变 (典型值), 包含 $R_{CC}+EE'$

$E_{rec}=f(R_G), I_F=450A, V_{CE}=400V$

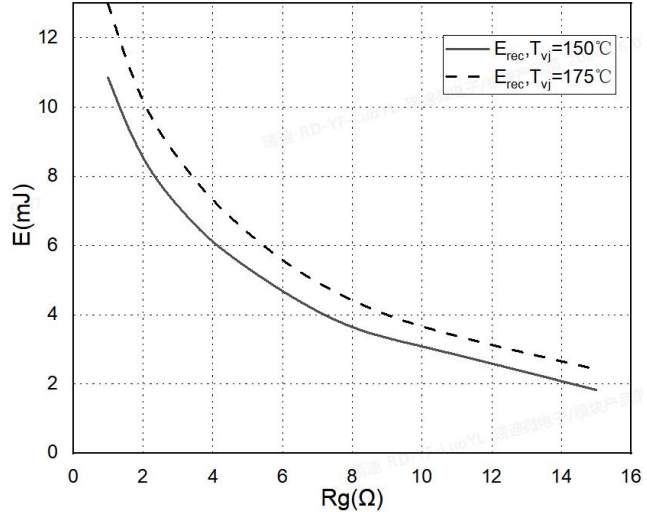

Transient thermal impedance FRD, Inverter

FRD 瞬态热阻, 逆变

$Z_{thJC}=f(t)$

Cooling fluid = 50%water/50% ethylene glycol;

$\Delta V/\Delta T=10.0dm^3/min; T_F=65^\circ C$

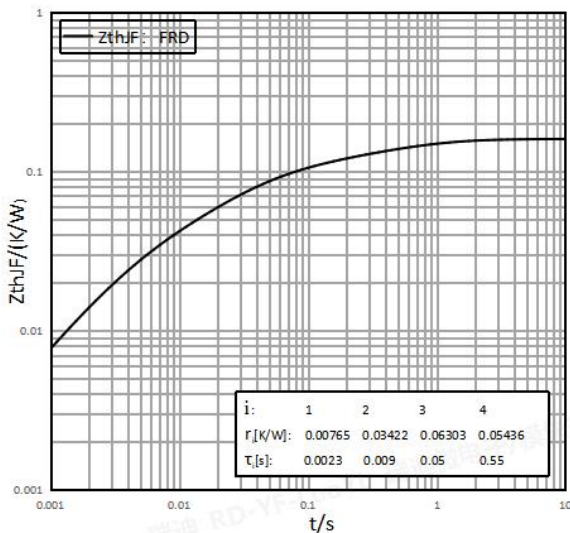

NTC Thermistor temperature characteristic (typical)

NTC 热敏电阻

$R=f(T)$

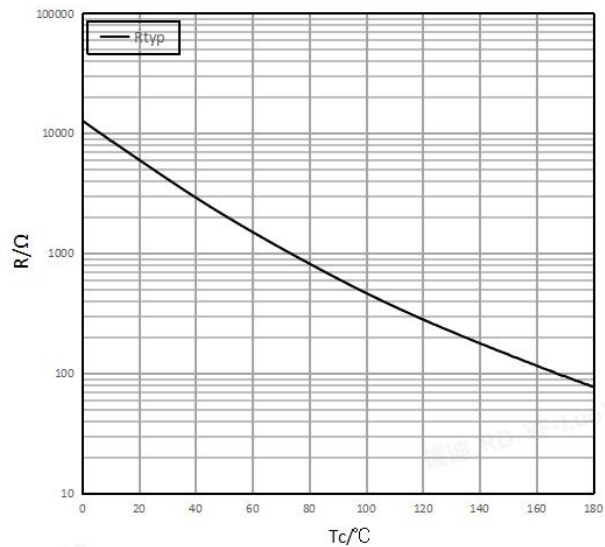

Internal Circuit / 内部电路

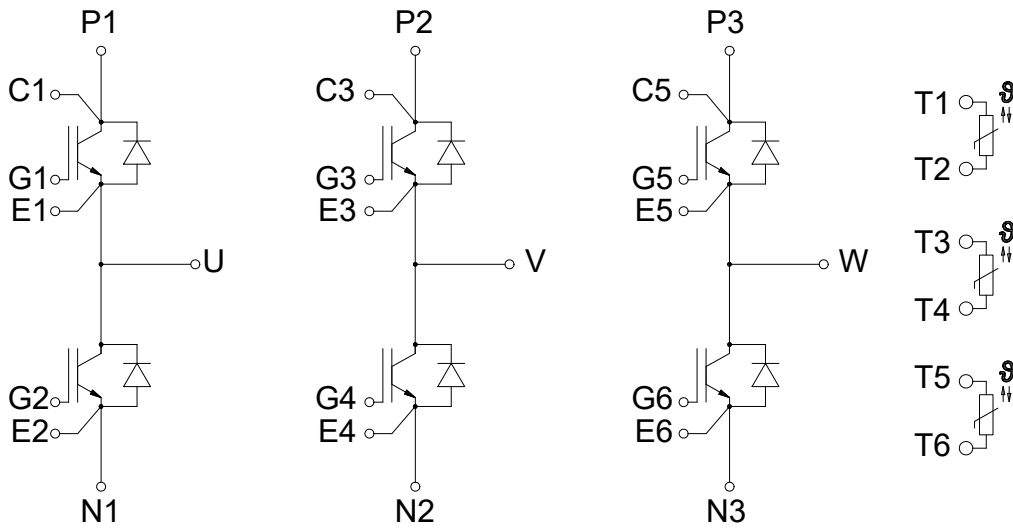

Package Dimension / 封装尺寸

Dimensions in Millimeters / 毫米为单位

